

Job Name _____

Contractor _____

Job Location _____

Approval _____

Engineer _____

Contractor's P.O. No. _____

Approval _____

Representative _____

LEAD FREE*

Series LF957RPDA, LF957NRPDA, LF957ZRPDA

Reduced Pressure Detector Assemblies

Sizes: 2½" – 10"

Series LF957RPDA, LF957NRPDA, LF957ZRPDA Reduced Pressure Detector Assemblies provide protection to the potable water system from contamination in accordance with national plumbing codes. The LF957RPDA, LF957NRPDA, LF957ZRPDA are normally used in health hazard applications to protect against backsiphonage and backpressure. The Watts LF957RPDA, LF957NRPDA, LF957ZRPDA are used to monitor unauthorized use of water from the fire protection system. They feature Lead Free* construction to comply with Lead Free* installation requirements.

Features

- Lead Free* construction
- Extremely compact design
- 70% lighter than traditional designs
- 304 (Schedule 40) stainless steel housing & sleeve
- Groove fittings allow integral pipeline adjustment
- Patented torsion spring check provides lowest pressure loss
- Unmatched ease of serviceability
- Replaceable check disc rubber
- Available with grooved butterfly valve shutoffs
- Bottom mounted cast stainless steel relief valve
- Metered bypass to detect leakage or theft of water from the fire sprinkler system

*The wetted surface of this product contacted by consumable water contains less than 0.25% of lead by weight.

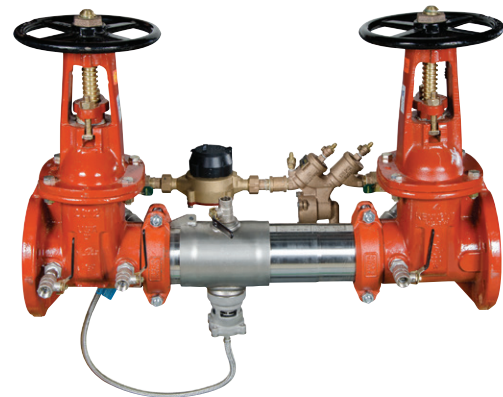
**LF957RPDA-OSY**

Specifications

The Lead Free* Reduced Pressure Detector Assembly shall consist of two independent torsion spring check modules, a differential pressure relief valve located between and below the two modules, two drip tight shutoff valves, and required torsion spring check modules and relief valve shall be contained within a sleeve accessible single housing constructed from 304 (Sch 40) stainless steel pipe with groove end connections. Torsion spring checks shall have reversible elastomer discs and in operation produce drip tight closure against reverse flow caused by backpressure or backsiphonage. The Lead Free* Reduced Pressure Detector Assemblies shall comply with state codes and standards, where applicable, requiring reduced lead content. The bypass assembly consists of a meter registering either gallon or cubic measurements, a double check assembly and required test cocks. Assembly shall be Watts Series LF957RPDA, LF957NRPDA, LF957ZRPDA.

NOTICE

The information contained herein is not intended to replace the full product installation and safety information available or the experience of a trained product installer. You are required to thoroughly read all installation instructions and product safety information before beginning the installation of this product.

Watts product specifications in U.S. customary units and metric are approximate and are provided for reference only. For precise measurements, please contact Watts Technical Service. Watts reserves the right to change or modify product design, construction, specifications, or materials without prior notice and without incurring any obligation to make such changes and modifications on Watts products previously or subsequently sold.

WATTS®

Available Models

Suffix:

- OSY – UL/FM outside stem and yoke, resilient seated gate valves
- BFG – UL/FM grooved gear operated butterfly valves with tamper switch

*OSY FxG – Flanged inlet gate connection and grooved outlet gate connection

*OSY GxF – Grooved inlet gate connection and flanged outlet gate connection

*OSY GxG – Grooved inlet gate connection and grooved outlet gate connection

Available with grooved NRS gate valves - consult factory†
 Post indicator plate and operating nut available - consult factory†
 †Consult factory for dimensions

Dimensions – Weight

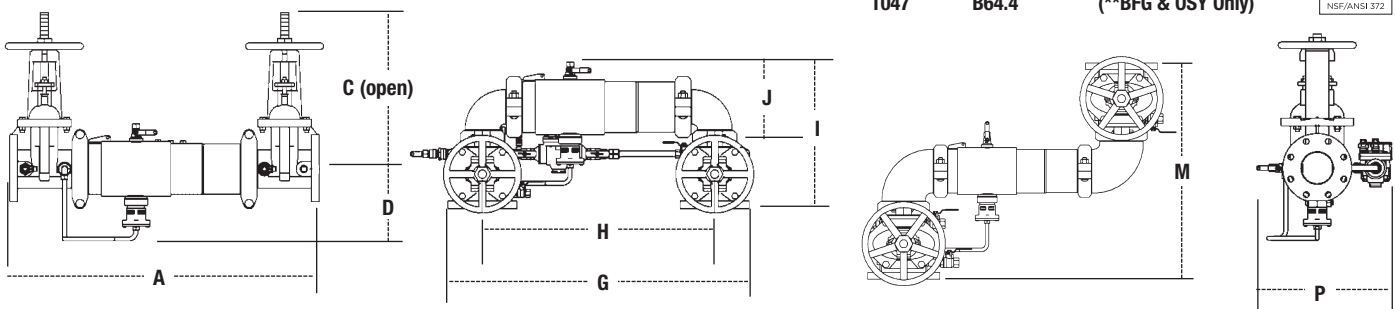

SIZE	DIMENSIONS												WEIGHT									
	A		C (OSY)		D		G		H		I		J		M		P		957RPDA		957NRPDA	
in.	in.	mm	in.	mm	in.	mm	in.	mm	in.	mm	in.	mm	in.	mm	in.	mm	in.	mm	lbs.	kgs.	lbs.	kgs.
2½	30¾	781	16⅞	416	6½	165	29⅛	738	21½	546	15½	393	8⅜	223	21¼	540	13⅞	335	142	64	150	68
3	31¾	806	18⅞	479	6⅞	170	30¼	768	22¼	565	17⅞	435	9⅞	233	23	584	14½	368	162	73	175	79
4	33¾	857	22¾	578	7	178	33	838	23½	597	18½	470	9⅞	252	26¼	667	15⅞	386	178	81	201	91
6	43½	1105	30⅞	765	8½	216	44¾	1137	33¼	845	23⅞	589	13⅞	332	32¼	819	19	483	312	142	353	160
8	49¾	1264	37¾	959	9⅞	246	54⅞	1375	40⅞	1019	27⅞	697	15⅞	399	36⅞	937	21⅞	538	497	225	572	259
10	57¾	1467	45¾	1162	11⅞	285	66	1676	49½	1257	32½	826	17⅞	440	44¼	1124	24	610	797	362	964	437

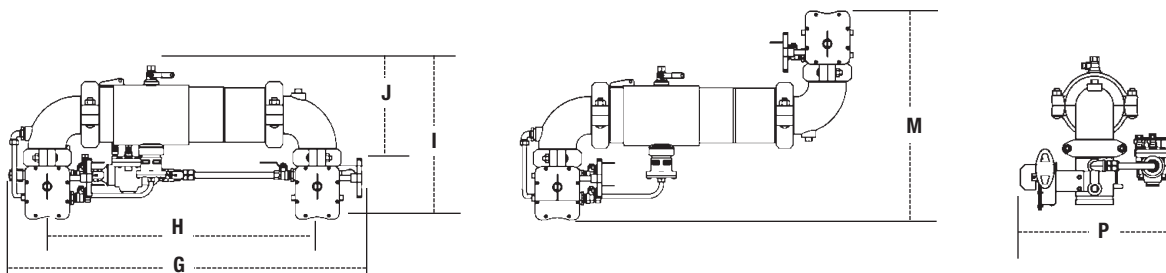

LF957NRPDABFG, LF957ZRPDABFG

SIZE	DIMENSIONS						WEIGHT							
	G		H		I		J		M		P		957RPDABFG	
in.	in.	mm	in.	mm	in.	mm	in.	mm	in.	mm	in.	mm	lbs.	kgs.
2½	32½	826	23	584	15½	394	9½	241	19⅞	502	15⅞	402	81	37
3	34	864	24	610	16⅞	414	10⅞	256	21¼	540	16⅞	410	84	38
4	35⅞	905	25½	648	17⅞	437	10⅞	279	23½	597	16⅞	422	101	46
6	46½	1181	35¼	895	20½	521	13½	343	27¼	692	19	483	174	79

Materials

- Housing & Sleeve: 304 (Schedule 40) Stainless Steel
- Elastomers: EPDM, Silicone and Buna 'N'
- Torsion Spring Checks: Noryl®, Stainless Steel
- Check Discs: Reversible Silicone or EPDM
- Test Cocks: Lead Free* Bronze Body
- Pins & Fasteners: 300 Series Stainless Steel
- Springs: Stainless Steel

Pressure – Temperature

- Temperature Range: 33°F – 110°F (0.5°C – 43°C)
- Maximum Working Pressure: 175psi (12.1 bar)

Approvals

- Approved by the Foundation for Cross-Connection Control and Hydraulic Research at The University of Southern California (FCCCHR-USC)
 (Excluding 6", 8", and 10" 'N' and 'Z' Pattern)
- AWWA C511-97

Capacity

Series LF957RPDA, LF957NRPDA, LF957ZRPDA flow curves as tested by Underwriters Laboratory.
(Excluding 6" Z Pattern configuration)

Flow characteristics collected using butterfly shutoff valves

—— Horizontal —— N-Pattern - - - - - Z-Pattern

Flow capacity chart identifies valve performance based upon rated water velocity up to 25fps

- Service Flow is typically determined by a rated velocity of 7.5fps based upon schedule 40 pipe.
- Rated Flow identifies maximum continuous duty performance determined by AWWA.
- UL Flow Rate is 150% of Rated Flow and is not recommended for continuous duty.
- AWWA Manual M22 [Appendix C] recommends that the maximum water velocity in services be not more than 10fps.

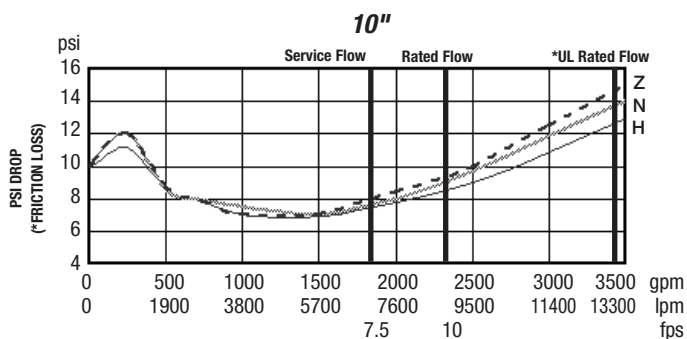
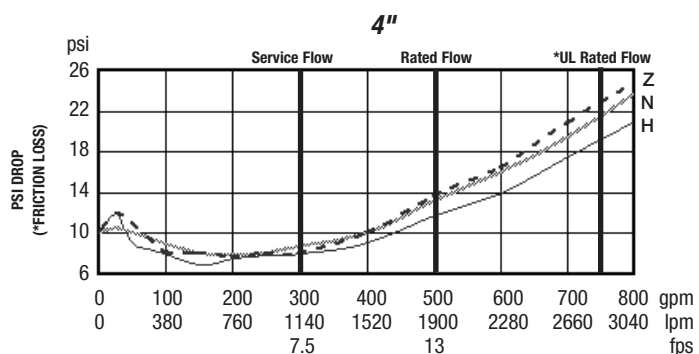
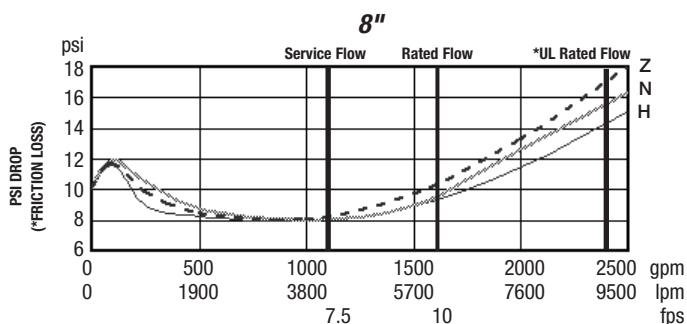
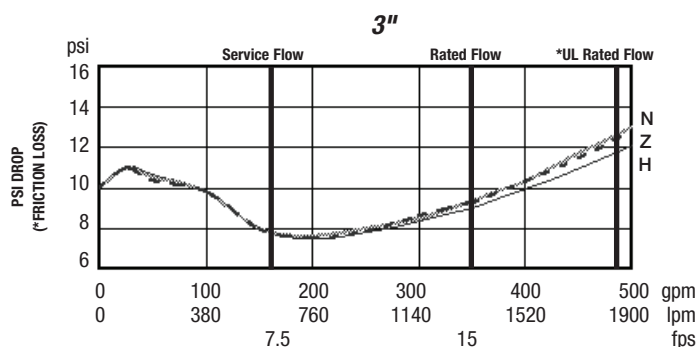
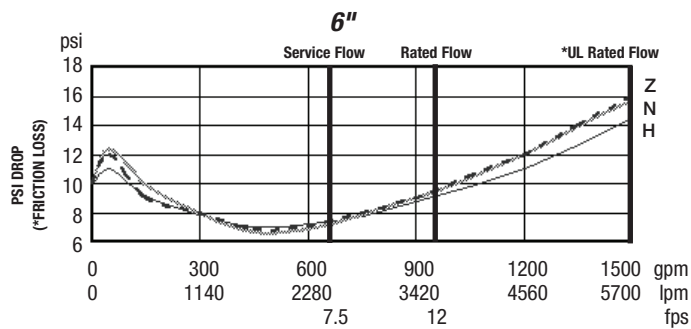
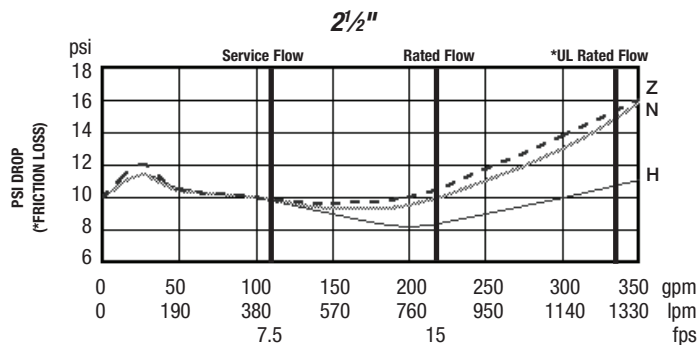

NOTICE

Inquire with governing authorities for local installation requirements



USA: Tel: (978) 689-6066 • Fax: (978) 975-8350 • Watts.com
Canada: Tel: (905) 332-4090 • Fax: (905) 332-7068 • Watts.ca
Latin America: Tel: (52) 55-4122-0138 • Watts.com